

## BROADBAND ANTENNA FOR WIRELESS COMMUNICATION

---

**Nisha Saha**

Microwave Engg.

Shri Ram Institute of Technology

Jabalpur, Madhya Pradesh

**Ravi Mohan**

Professor

Shri Ram Institute of Technology

Jabalpur, Madhya Pradesh

**Divyanshu Rao**

Assistant Professor

Shri Ram Institute of Technology

Jabalpur, Madhya Pradesh

---

**ABSTRACT:** UWB is a short distance radio communication technology that can perform high speed communications with speeds of more than 100Mbps modern communication system requires a single antenna to cover several wireless bands. The UWB systems have received greater attention in indoor and handheld wireless communication after the allocation of 3.1- 10.6 GHz by the Federal Communications Commission (FCC) for UWB applications. By deploying multiple antennas for transmission an array gain and diversity gain can be accomplished, therefore, the spectral efficiency and reliability is increased significantly and an increase in channel capacity without costing the additional bandwidth or transmit power. MIMO antenna systems require high isolation of less than -16 dB between antenna ports and a compact size for applications in portable devices. This thesis concentrates on the analysis and design of single patch and MIMO antennas with a compact planar profile that have an operating range in the entire UWB (3.1- 10.6 GHz) by having two notch bands for narrow band applications. Some narrow band applications like WiMAX, WLAN etc. can cause interference to the UWB antenna system

**KEYWORDS:** UWB (Ultra wide Band); Microstrip patch antenna; Slot; Planner monopole antenna.

---

### 1. INTRODUCTION

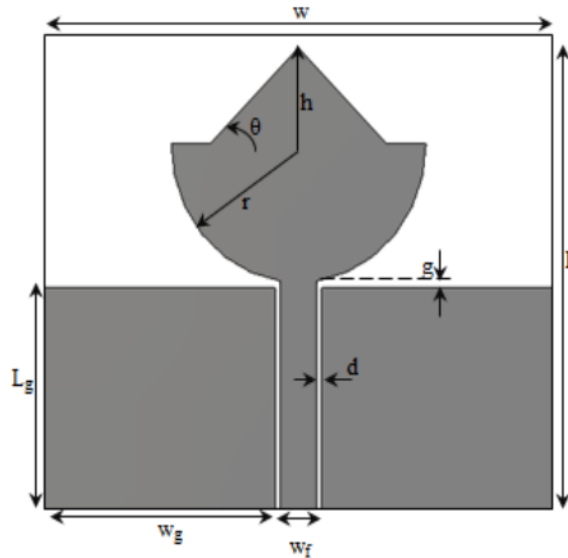
According to FCC [13] the UWB antenna should be operated in the range from 3.1 to 10.6 GHz bandwidth for commercial use. Micro strip antennas have narrow impedance bandwidth. To increase the impedance bandwidth so many techniques are implemented [14] among them some are directly coupled and gap coupled parasitic patches [15], implementation using U-slot patches [16] and E-shapes patches [17]. Using above techniques ten percent of bandwidth can be increased. Different feed lines are used for investigating different types of UWB antennas like micro strip line [18]-[19], coplanar waveguide (CPW) and various shapes like the crescent patch.

The design and analysis of simple compact lotus shaped planar monopole antennas and dual notch antenna are presented. The proposed antennas fabricated on a 44×38×1.58mm<sup>3</sup> on a FR4 substrate. Simple antenna covers the frequency range from 2.86 to 14.0 GHz. The dual notch antenna covers the wide range 2.8 to 11 GHz with notch frequencies at 3.458 and 5.51GHz ranging from 3.35GHz-3.566GHz and 5.285GHz-5.771GHz frequencies. The dual notch antenna can be used to avoid narrow band applications named as WiMAX and WLAN from UWB frequency range to avoid the interference.

### 2. ANTENNA DESIGN

Figure 1 shows the proposed antenna with its parameters. The proposed antenna radiator is combination of semicircular and triangular patch (lotus shape). Which is fed by 50 Ω CPW micro strip line The antenna is oriented on a standard FR-4 substrate having a dielectric constant  $\epsilon_r=4.4$ , loss tangent

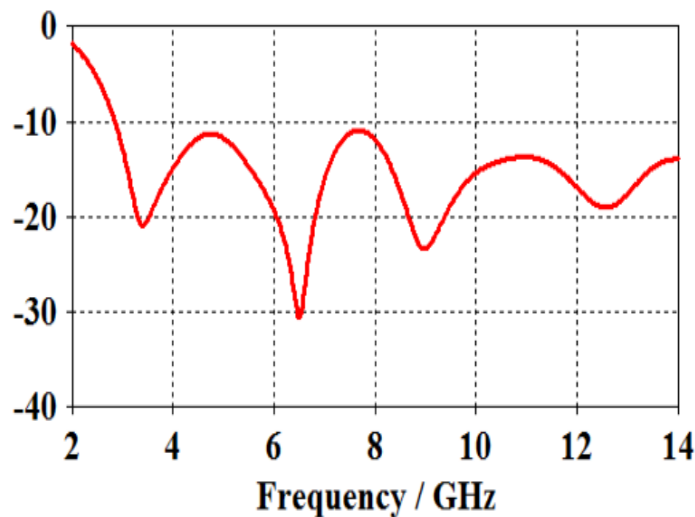
$\tan \delta = 0.025$  and thickness of 1.58mm. The dimensions of designed antenna are  $w=44$  mm,  $L=38$  mm,  $r=11$  mm,  $\theta=45^\circ$ ,  $h=7.6$  mm,  $w_g=20$  mm,  $L_g=17.6$  mm,  $w_f=3.2$  mm,  $g=0.6$  mm,  $d=0.4$ mm.



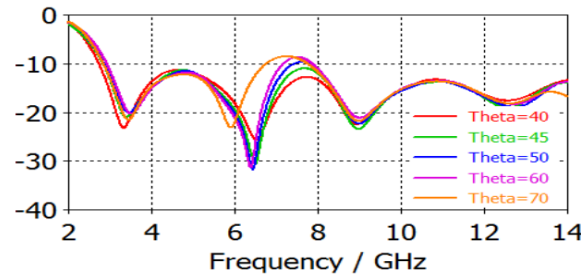
**Figure 1 Proposed geometry and its parameter**

**3. SIMULATION, RESULT AND DISSCUSSION**

The simulation is performed using CST MW Studio 2012. The S11 of designed antenna is shown in Fig. 2. It is observed that the impedance bandwidth of 132.14 % from 2.86 to 14 GHz is achieved, which is suitable for UWB application. Fig. 3 depicts the S11 curves with various angles with other fixed parameters the angle ( $\theta$ ) affects the resonance frequencies and the impedance bandwidth of antenna. It can be seen that the lower edges of the S!! Curve moving towards higher frequency and the impedance bandwidth decreases. Another observation is for radius ( $r$ ) of lotus shape geometry. It can be seen from Fig. 4, when we increasing the ' $r$ ', it affects the resonance frequencies shifts towards the higher frequency as well as the impedance bandwidth of antenna not matching for UWB frequency range. At  $r=11$  mm the impedance bandwidth is well matched below the -10 dB. Fig. 4 depicts the radiation patterns of proposed lotus shape planar antenna at 3.4, 6.5 and 9.0 GHz. The patterns are Omnidirectional in nature for two principal planes (E- and Hplane). Figure 6 the radiation pattern of designed UWB antenna at 3.4 GHz,6.5 GHz and 9GHz . The antenna gain is plotted in Fig. 6. It is varied between 2.1 dB and 5.36 dB.

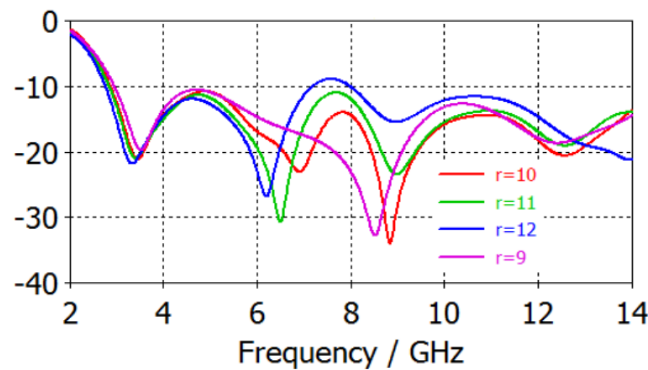


**Figure 2 Simulated S11 curve of proposed UWB antenna**

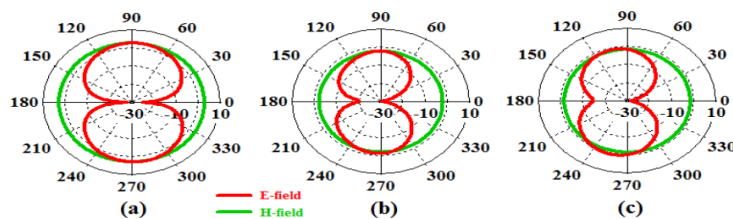


**Figure 3 Simulated S11 curves of different angles (theta) proposed UWB antenna**

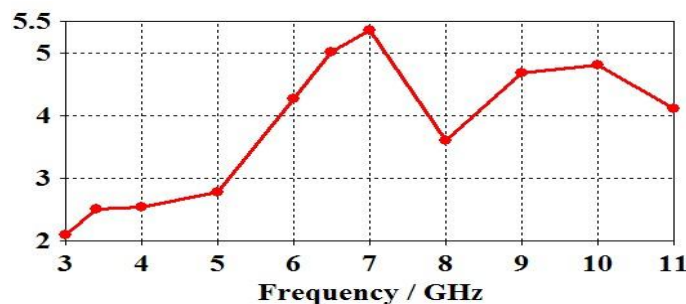
The return loss curves for the proposed antenna system are shown in figure 7. The result indicate that the  $s_{11} < -10$  dB over the frequency range except notch frequency range. The curves of S11 and S22 are identical to each other because of the reciprocity and similar with S12 and S21 for the antennas placed in parallel and 180 degree respectively. But when the antennas are placed 90 degrees on the substrate the S11 and S21 are different because, with respect to length and width the two patch antennas are having different dimension of the substrate. The antenna system consisting the elements placed on parallel on the substrate is fabricated and measured.



**Figure 4 Simulated S11 curves of different radii for proposed UWB antenna**



**Figure 5 Simulated radiation patterns of designed UWB antenna at (a) 3.4 GHz (b) 6.5GHz (c)9 GHz**



**Figure 6 Simulated gains vs. frequency curve of proposed UWB antenna**

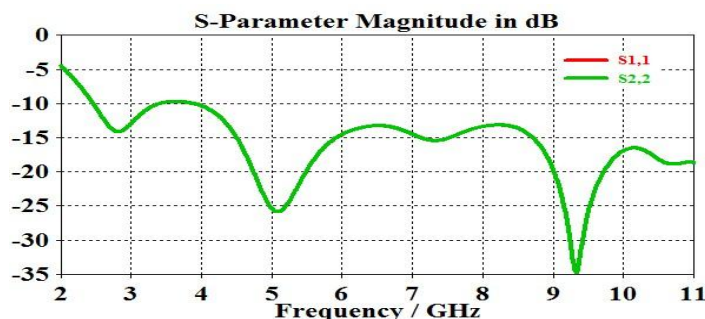


Figure 7 Simulated S11 curves for the antennas placed 0 degrees

#### 4. CONCLUSION

Ultra wide band antenna geometries are designed and implemented. For this, two single patch antennas are designed for Ultra wide band applications by considering the notch for one of the antenna. The MIMO antennas are designed by using these simple geometries by placing the antenna elements in three different angular positions. The conclusions are as follows: a) Ultra-Wide band behavior of the antenna using lotus shaped geometry is successfully achieved. b) Two Notch bands are successfully achieved by using two slots in the design to avoid interference at desired frequencies. c) Fractional bandwidth greater than 120% is achieved for Ultra wide band antenna. d) The MIMO antenna systems are designed and maximum isolation is achieved by using the fork like design on ground plane. e) The MIMO antenna systems are designed with notch bands to avoid the interference at desired frequencies.

#### REFERENCES

1. Young Man Kim, "Ultra Wide Band (UWB) Technology and Applications", NEST group, The Ohio State University, July 10, 2003.
2. G.Brzezina, "Planar Antennas in LTCC Technology for Ultra-Wideband Applications," M.A.Sc. Thesis, Carleton University, Canada, 2005.
3. J.Powell, "Antenna Design for Ultra Wideband Radio," M. A. Sc. Thesis, Massachusetts Institute of Technology, USA, May 2004.
4. Z.Chen, T. See and X.Qing, "Small Printed Ultra Wideband Antenna with Reduced Ground Plane Effect," IEEE Transactions on Antennas and Propagation, vol. 55, pp. 383- 388, February 2007.
5. C. A. Balanis, "Antenna Theory - Analysis and Design," 2nd edition, John Wiley.
6. W. F. Richards, Y. T. Lo, and D. D. Harrison, "An Improved Theory of Microstrip Antennas with Applications," IEEE Trans. Antennas Propagat., Vol. AP-29, No. 1, pp. 38-46, January 1981.
7. D. H. Schaubert, F. G. Farrar, A. Sindoris, and S. T. Hayes, "Micro strip Antennas with Frequency Agility and Polarization Diversity," IEEE Trans. Antennas Propagat., Vol. AP-29, No. 1, pp. 118-123, January 1981.
8. P. Bhartia and I. J. Bahl, "Frequency Agile Microstrip Antennas," Microwave Journal, pp. 67-70, October 1982.
9. W. F. Richards and Y. T. Lo, "Theoretical and Experimental Investigation of a Microstrip Radiator with Multiple Lumped Linear Loads," Electromagnetics, Vol. 3, No. 3-4, pp. 371-385, July-December 1983.
10. W. F. Richards and S. A. Long, "Impedance Control of Micro strip Antennas Utilizing Reactive Loading," Proc. Intl. Telemetry Conf., pp. 285-290, Las Vegas, 1986.
11. W. F. Richards and S. A. Long, "Adaptive Pattern Control of a Reactively Loaded, DualMode Microstrip Antenna," Proc. Intl. Telemetry Conf., pp. 291-296, Las Vegas, 1986. 12. M. P. Purchine and J. T. Aberle, "A Tunable L-Band Circular Micro strip Patch Antenna," Microwave Journal, pp. 80, 84, 87, and 88, October 1994.
12. Federal Communications Commission, First report and order, revision of Part 15 of Commission's rule regarding ultra-wideband transmission system FCC 02-48, Washington, DC, April 2002
13. K.L. Wong, "Compact and broadband micro strip antennas" (John Wiley & Sons, 2002)
14. C.K. Wu, K.L. Wong, "Broadband micro strip antenna with directly coupled and gap-coupled parasitic patches", Microw. Opt. Technol. Lett., 1999, vol. 22, no. 5, pp. 348-349
15. T. Huynh, K.F. Lee, "Single-layer single-patch wideband microstrip antenna", Electron.Lett., 1995, vol. 31,no. 3, pp. 1310-1311
16. K.L. Wong, W.H. Hsu: "A broadband rectangular patch antenna with a pair of wide slits", IEEE Trans. Antennas Propag., 2001, vol. 49, pp. 1345-1347
17. J. Lao, R. Jin, J. Geng, Q. Wu, "An ultra-wideband micro strip elliptical slot antenna exited by a circular patch", Microw. Opt. Technol. Lett., 2008, vol. 50, no. 4, pp. 845-846
18. A.C. Azenui, H.Y.D. Yang, "A printed crescent patch antenna for ultra wideband applications", IEEE Antennas Wirel. Propag. Lett., 2007, vol. 6, pp. 113-116